

RP400 Series

3-Phase Wye 1-Stage Power Line Filter

**RP400
3PH WYE TO 300A**

ROHS COMPLIANT



Specifications

Operating Frequency: DC - 60Hz
Operating Voltage: 480V +10%
Ambient Temperature: 50°C
Inrush Rating: 20x (10ms), 1.5x (1min)
Climatic Category: 25/100/21
Hipot Rating: 3500VDC (P/N - E)
Terminations: 15/30/35/40/45A (M5)
 60/65/100A (M6)
 150/200A (M10), 300A (M12)
Safety Approval: UR/cUR/EN133200

Leakage Current

Ycap, nF	mA, 400V/50HZ
0	0
.22	.004
.47	.009
1	.018
2.2	.04
3.3	.06
4.7	.09
10	.18
22	.4
100	1.8
1000	18
2200	30

Part Number/Ordering

RP400	-X (Amps)	-Y (Y-cap, nF)	-T
	15	0	S
	30	.22	
	35	.47	
	40	1	
	45	2.2	
	60	4.7	
	65	10	
	100	22	
	150	100	
	200	1000	
	300	2200	

Note: Use any -Y (Y-cap) with any -X (Amps) rating
 e.g. RP400-60-100-S
 60 Amps with 100nF y-caps

Schematic

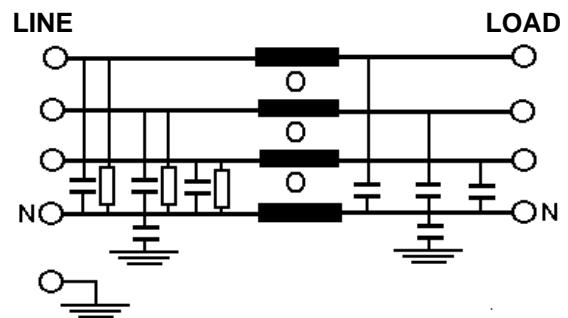

Dimensions shown for reference only.
 Specifications subject to change.

RADIUS POWER
 Standard & Custom Products

www.radiuspower.com
 PH 714-289-0055
 FAX 714-289-214

RP400 Typical Insertion Loss, 50/50ohm

15 / 30 AMP

FREQ(MHz)	.15	.5	1	10	30
CM, dB	60	70	70	55	50
DM, dB	48	70	75	75	65

35 AMP

FREQ(MHz)	.15	.5	1	10	30
CM, dB	55	62	65	50	45
DM, dB	36	55	60	60	50

40 / 45 AMP

FREQ(MHz)	.15	.5	1	10	30
CM, dB	58	68	70	55	50
DM, dB	46	65	70	70	65

60 / 65 AMP

FREQ(MHz)	.15	.5	1	10	30
CM, dB	57	65	70	55	50
DM, dB	45	64	70	70	65

100 AMP

FREQ(MHz)	.15	.5	1	10	30
CM, dB	65	70	70	60	50
DM, dB	50	75	75	60	55

150 AMP

FREQ(MHz)	.15	.5	1	10	30
CM, dB	55	65	60	48	40
DM, dB	50	75	70	45	45

200 / 300 AMP

FREQ(MHz)	.15	.5	1	10	30
CM, dB	50	50	50	45	40
DM, dB	50	45	45	40	30

Mechanicals

I	A	B	C	D	E	F	MTG
15	4.25	3	2.75	5.5	2.5	4.85	.2x.3
30	5	4	2.75	6.7	3.25	5.8	.2x.4
35	3.9	3.3	1.75	2	3.75	---	.2x.4
40	4.25	4.25	2.25	5.75	3.5	5	.2x.4
45	7	4	3.25	8.7	3.25	7.8	.2x.4
60	8	5	3.5	10	4	9	.25x.5
65	7.25	5.5	3	8.8	4.75	8.06	.2x.4
100/150	10	6.6	4.5	12	5.12	11	.3x.6
200/300	13	6.6	4.5	15.75	5.12	14.7	.3x.6

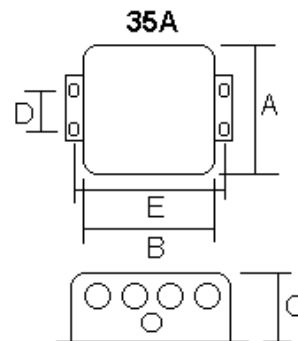
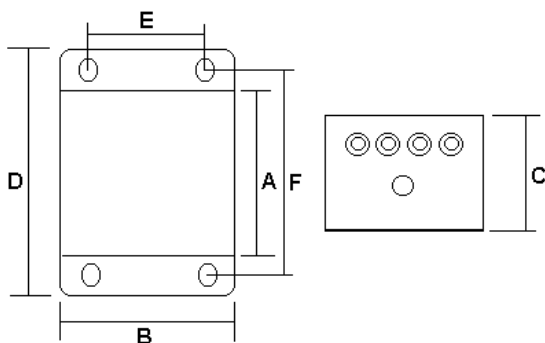

Dimensions shown for reference only.
Specifications subject to change.

RADIUS POWER
Standard & Custom Products

www.radiuspower.com
PH 714-289-0055
FAX 714-289-214